



Elbow 90°



Elbow 45°



Reducing Elbow



Elbow Inside Thread

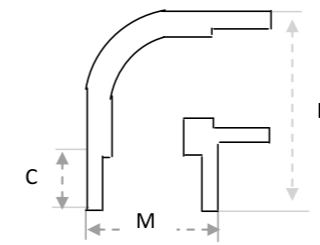

SIZES	M	C	H
1/2"	27.85	19.50	46.24
3/4"	33.40	25.45	56.15
1"	40.72	28.68	65.95
1 1/4"	49.95	32.02	78.98
1 1/2"	56.35	28.00	81.30
2"	68.80	30.00	95.42
3"	98.40	52.20	153.65
4"	124.25	51.10	170.20
110mm	119.65	50.00	160.95
160mm	176.00	76.60	247.10

Elbow 90°

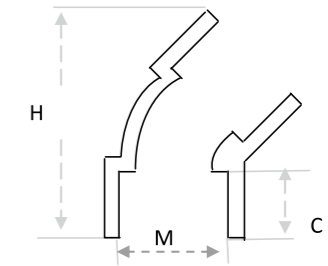

SIZES	M	C	H
1.1/2"	56.20	28.20	96.00
2"	68.50	25.30	101.70
3"	98.15	40.50	152.60
4"	123.95	51.00	192.00
110mm	119.50	50	185.40
160mm	176.00	70.50	290.25

Elbow 45°

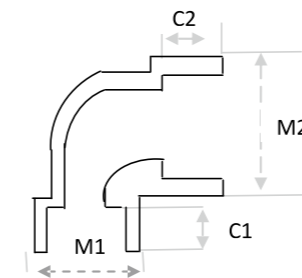

SIZES	M1	M2	C1	C2
1"x1" 1/2	29.80	43.20	22.60	28.50
1" x 3/4"	36.40	43.15	25.70	28.80
1 1/2"x1 1/4"	50.00	56.20	24.20	27.00
2"x1 1/2"	56.41	68.30	27.40	29.60

Reducing Elbow

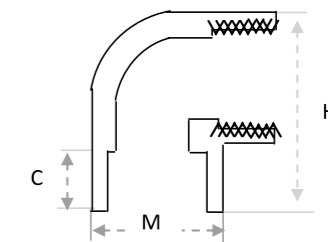

SIZES	M	C	H
1 1/4"	50.80	32.40	80.00
1 1/2"	56.11	28.10	84.28
2"	70.00	36.60	95.50

Elbow inside Thread



Elbow 90° with Door



Tee



Tee Y



Tee with Door

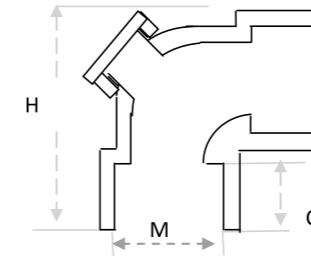

SIZES	M	C	H
110mm	110.00	49.40	176.10
4"	114.65	51.20	180.20

Elbow 90° with Door

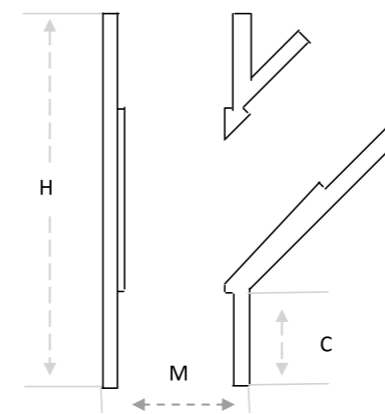

SIZES	M	C	H
1 1/2"	56.00	28.45	135.30
2"	68.65	30.40	157.00
3"	98.05	48.30	232.00
4"	119.80	50.00	266.25
110 mm	123.73	51.40	270.00

Tee Y

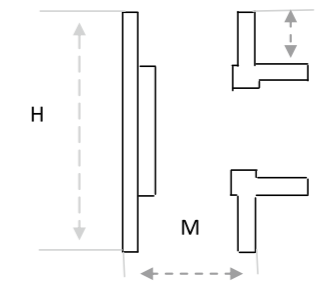

Tee

SIZES	M	C	H
1/2"	27.75	19.50	63.20
3/4"	33.80	25.40	79.00
1"	41.10	28.42	91.52
1 1/4"	50.12	31.50	107.35
1 1/2"	56.30	29.00	106.50
2"	68.60	30.10	123.05
3"	98.20	47.90	188.00
4"	123.55	51.50	219.22
100mm	119.70	50.00	214.20
160mm	176.00	89.30	348.50

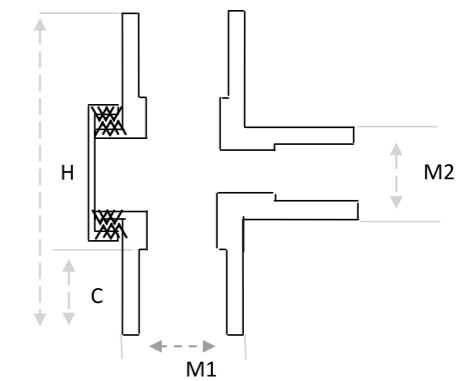

SIZES	M1	M2	C	H
110mm	120.23	120.30	48.80	213.00
4"	128.00	124.00	47.50	215.00
4"x2"	124.30	68.38	51.25	219.00
4"x3"	123.60	98.70	48.20	219.00

Tee with Door



P Trap



Socket



Socket with Female Thread



End Cap Socket

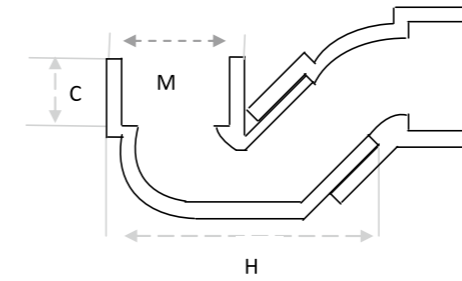

SIZES	M	C	H
2"	68.25	25.17	147.40
3"	98.20	42.81	217.00
4"	124.10	50.74	262.00
110mm	119.40	50.40	256.00

P Trap

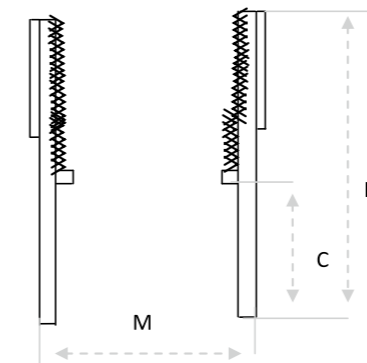

SIZES	M	C	H
3/4"	32.45	21.00	42.20

Socket with Female Thread

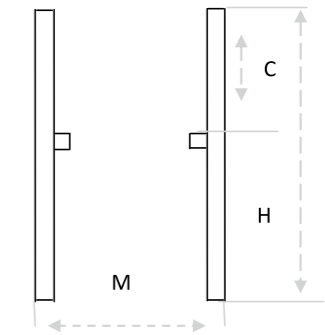

SIZES	M	C	H
1/2"	28.00	19.85	42.10
3/4"	33.50	25.10	53.20
1"	41.01	28.80	60.20
1.1/4"	50.27	29.70	62.00
1.1/2"	56.00	32.90	71.50
2"	69.00	36.10	74.60
3"	98.60	39.20	83.30
4"	128.00	51.00	106.50
110mm	120.00	49.70	104.00
160mm	178.00	68.30	160.00

Socket

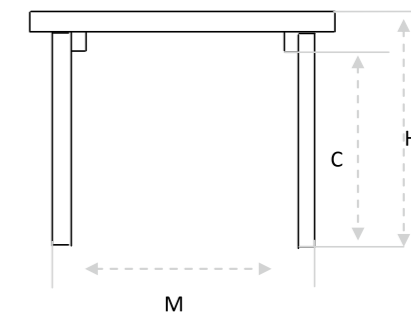

SIZES	M	C	H
160 mm	168.25	60.37	91.60

End Cap Socket



Socket Reducer



Reducer



Air Vent Cowl



Socket with Male Thread

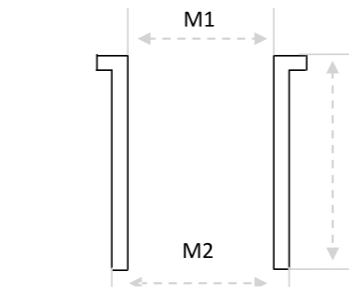

SIZES	M1	M2	H
110 mm	110.00	114.00	64.60

Socket Reducer

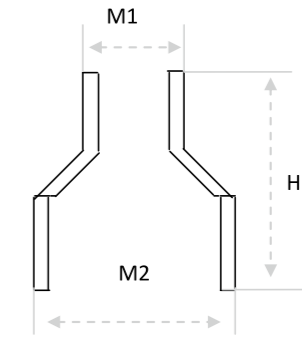

SIZES	M1	M2	H
4"X2"	128.00	57.00	110.00

Reducer

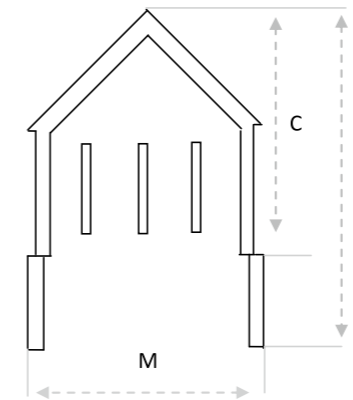

SIZES	M	C	H
4"	122.40	55.17	183

Air Vent Cowl

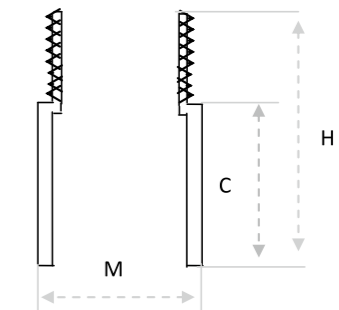

SIZES	M	C	H
1/2"	27.60	20.00	42.60
3/4"	33.40	26.00	49.00
1"	41.00	29.00	58.20
1 1/4"	50.00	32.00	59.80
1 1/2"	56.10	41.10	67.80
2"	68.57	34.70	63.65
3"	99.00	60.50	100.40
110mm	120.00	49	99.00

Socket with Male Thread